

DISTRICT 3 2018 JOURNAL

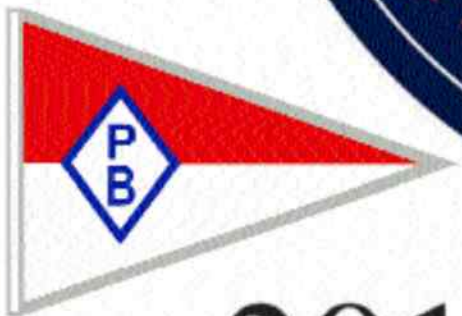

**UNITED STATES
POWER SQUADRONS**

**Best Wishes to Our Own
Commander Fred Smith
and his
D3 DEFENDERS**



From
the members
of Peconic Bay
Power Squadron

2018 - 2019



District 3 Rendezvous East **Mitchell Park Marina, Greenport, New York**

27 July - 29 July 2018

Friday

1600-1700

Set-up and Bracelet Distribution

1700 -1830

District 3 Defenders Commander's Cocktail Party with music by Reggie Tunes

1900 - 2300

Karaoke/Music with Reggie Tunes, Hot Dogs and Beer

Saturday

0830

Continental Breakfast - courtesy of Peconic Bay Squadron

1030

Assemble for Flag RaisingOn Lawn....Uniform D or E

1100

Flag Raising

1145

Bocce Squadron Challenge by Peconic Bay - 4 per Squadron Team

1300 - 1530

Squadron Hospitality Mixer, Music by DJ Ralph

1530 - 1830

Clean-up/Set-up, Tour Greenport, Relax!

1830

Evening Program bracelet check-in

1900 - 2300

Red, White & Blue Theme Dance with DJ Ralph

2200-2300

Raffle Drawing and Clean-up

Sunday

1100 - Departure time for boats

Safe Trip Home!

Journal Staff Chair: Stf/C Angelo Giovanniello, SN, 631-661-5318

Advertising Information: D/Lt Heidi Dearing, S, 516-804-9661

Content: D/1stLt Lucy Jackson, SN, 631-289-2328

Photographers: D/1stLt George Hoffman, JN • D/Lt/C Betsy Mandara, AP • Stf/C Nina Anastasio, SN



**Welcome District Commander
Fred Smith
As our new USPS District 3 Leader
and Lots of Luck to
Past District Commander
Ann Frenz**

"To stay the course sometimes you must make waves"



**RDH Crystal Gardens
190-25 Woodhull Avenue Hollis, NY 11423
718-217-6300**

**Newly renovated studios, 1-2 Bedroom Apartments
Conveniently located to major transportation & LIRR**

**Continued success on providing awareness of water
safety in the community**

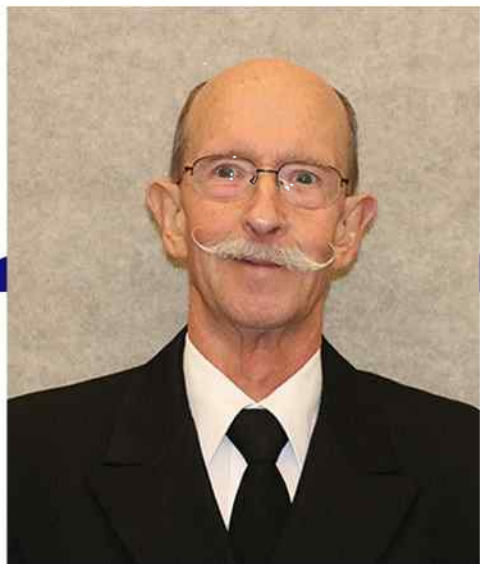

A Message from
Fred Smith, AP
District Commander

Thank You Peconic Bay for your support and for the honor for being nominated for the D/C position. Thanks also to the Nominating Committee for their hard work, putting together a fine slate of Officers and Committees. We are all proud to be working with an outstanding group of Squadron Commanders and their Bridges.

This will be a momentous year, with many Squadrons and District 3, celebrating significant Anniversary milestones: Brooklyn, 100, South Shore, 90, Neptune, 80, District 3, 80, and Port Washington 70. We are planning special presentations at our Fall Conference, with the C/C Gary Chaney, SN and Ann, as our guests!

I am proud to follow the heritage of so many dedicated District Commanders, who served over the last 80 years. It is difficult to imagine the early days of District 3, much less of USPS in 1914. The changes of technology are tremendous, the ways we teach, navigate our boats and communicate have changed, but our core values have not. They remain: a love of the boating tradition, a desire to educate the public and our members to be safer on the water and to be of service in our communities.

To enable us to continue this tradition, we must reach out to our Members and the Public, with a fresh view of who we are: United States Power Squadrons, "Americas Boating Club". The ABC name and Logo has been given new prominence in our marketing efforts to reach a broader target audience. It represents us as boaters having fun, using Power, Sail and Paddles.

A National Advertising campaign has begun, new guide lines for branding, and new promotional videos and tools are ready. District 3 and many Squadrons are already utilizing the logos provided to a variety of applications.

The Defenders Team asks for your support and participation, as we move forward. We are all the faces of USPS and your voice and ideas are important.

Today we represent the past and present, tomorrow, working together, we will be the future!



*Whitmore Group Salutes
Fred Smith*

WGC

WHITMORE GROUP

Business Insurance • Personal Insurance • Health Insurance • Life Insurance

**370 Old Country Road, suite 200
Garden City, NY 11530
(516) 746-4141**



J/P/D/C COMMANDER'S MESSAGE **ANN FRENZ, SN**

It has been a year and it is time for me to turn over the helm of District 3. It has been an absolute pleasure for me to serve as District Commander this past year. I would like to thank all of my Seafaring Frenz Commanders for their hard work and dedication to their squadrons, District 3 and the United States Power Squadrons. Richard and I appreciate your support and hope your friendship will continue for years to come. You are our family. My seven years on the District 3 Bridge have been a wonderful experience.

I especially want to thank my Flag Lieutenant, P/C Alicia Pilek, AP. who has been a real big help to me and an asset to District 3 this year. I would also like to thank my Bridge, Advisors and Aides who gave me their support this year. As you know I always look at the right way to do what has to be done and I thank those who assisted in guiding me. A special thank you to our Chaplain, D/Lt Mary Anne Mc Coy, SN who prayed for us all. Thank you all for making this a fun, successful year.

Education is important to each of you. I know all active squadrons are promoting USPS through courses and will continue to make all your activities fun. Continue to promote the United States Power Squadrons which is America's Boating Club, For Boaters, By Boaters.

I cannot end this year without thanking P/D/C Richard, my husband. Even though there have been some tough times due to illness, you were there. I appreciate all your help and understanding and know that you all will continue to work hard for District 3. As a P/D/C, I will be there whenever I am needed. Remember to enjoy what you do. My wish for the future is calm seas and much success!.



SHIP ASHORE MARINA INC

**30 REDWOOD ROAD
SAG HARBOR, NY 11963**

FREDERICK PICKERING

TEL 631-725-3755 • FAX 631-725-4478



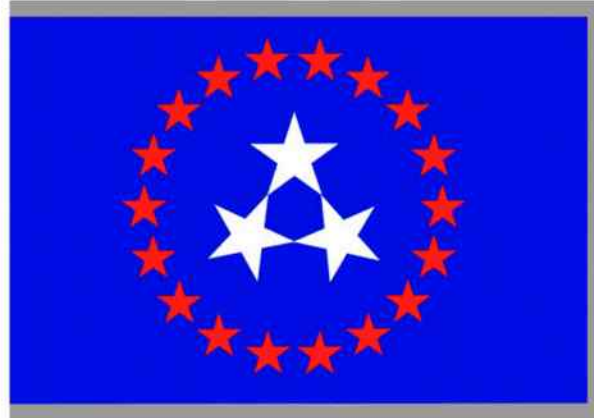

**THE PAST DISTRICT COMMANDERS
OF DISTRICT 3
WISH FRED SMITH, AP
THE BEST OF LUCK AND
A SUCCESSFUL WATCH**

1982 Daniel Katz, SN
1985 John Holub, SN
1989 Guy Anastasio, SN
2000 Edward Bauer, SN
2002 Richard Frenz, SN
2003 Robert Holub, SN
2004 Angelo Giovanniello, SN
2005 Janet Taylor, SN
2006 Ron Friedmann, AP

2008 Peter TenBrink, SN
2009 Gardham Comb, SN
2010 John Sanfilippo, AP
2012 Lawrence Postel, SN
2013 Barry Rush, SN
2014 Daniel Flinn, SN
2015 Ann Peltier, SN
2016 Neil Phillips, JN
2017 Ann Frenz, SN



**CONGRATULATIONS
AND BEST WISHES
FRED SMITH**

**WE'RE PROUD TO BE
YOUR FRIENDS**

**ABIGAL
SAL - JEFF - MARK**

Abigal press inc.

97-35 133rd Avenue, Ozone Park. NY 11417



THE BRIDGE



FRED SMITH, AP - District Commander and Nancy

Fred joined Peconic Bay in 2001 serving as Commander for 2006-2008 and 2011, winning the Commander's Challenge in 2008. In 2012-2013 he served as Asst. District Treasurer working up the bridge to Commander. Fred is a Certified Instructor for USPS, N.Y.S., a Vessel Safety Examiner and has earned 17 Merit Marks.

Fred was raised in Babylon and joined the Navy after High School. He earned business degrees from SCCC and Hofstra University and has lived in Mattituck since 1999 with Nancy his wife of almost 50 years.

Fred retired in 2001 and has been actively volunteering as Trustee of the Mattituck-Laurel Historical Society and was also a Past President, Mattituck Community Fund President for four years, current Board Member, American Legion member and more...

Fred loves boating and fishing, with his 100 lb Yellow Lab, Ozzy, on his Mainship Pilot 30 "Maiden USA". Nancy, a graduate of Wagner College & Hofstra, is a "Master Gardener" who joins Fred for cruises to various ports and around the Forks!

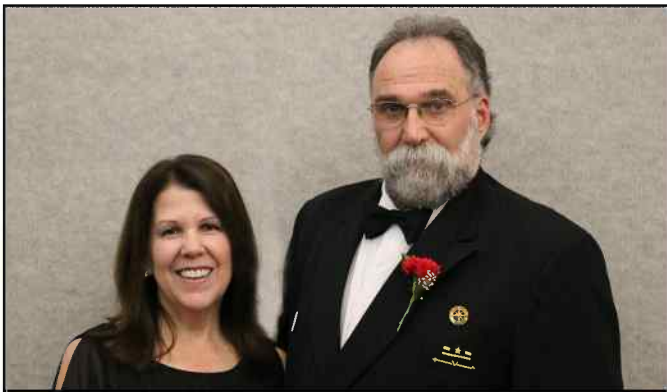

TOM PILEK, AP - Executive Officer and Alicia

Tom joined Great South Bay Power Squadron in 2005 along with his wife, Alicia, and in that same year, they purchased their first boat, a 22 ft Walkaround. Being novice boaters, Tom and Alicia felt it was very important to take a safe boating course and have been part of the Power Squadron family ever since.

Tom is an Advanced Pilot and has taken all elective courses in addition to the three Leadership Development courses. Tom was Squadron Secretary in 2008-2009, Administrative Officer 2010, Executive Officer 2011 and a Lantern Commander in 2012, District Assistant Secretary in 2013 and 2014 and District Secretary in 2015 and 2016, District Administrative Officer in 2017. Tom has eleven merit marks.

Tom has worked in the insurance field for 40 years. He is currently a Managing Director in the National Accounts Property Division for a major insurance company. Tom and Alicia enjoy their 36' Carver Mariner "GRATEFUL" and being on the water with family and friends.



LUANN KAZANECKI, SN - Educational Officer and Gene

Luann has been a member of America's Boating Club, Great South Bay Power Squadron since 1997. She has worked in different positions on the Squadron and District levels and will be serving her second year as Educational Officer in 2018.

Luann and Gene have been married for 32 years and have two wonderful daughters, Samantha and Nicole. They own a 37' Sea Ray Sedan Bridge "Instigator" and enjoy taking boating trips with fellow squadron members. Samantha and her husband Andrew welcomed their first son AJ in 2017 and the family is looking forward to celebrating Nicole and her fiancé Nick's wedding in 2018.

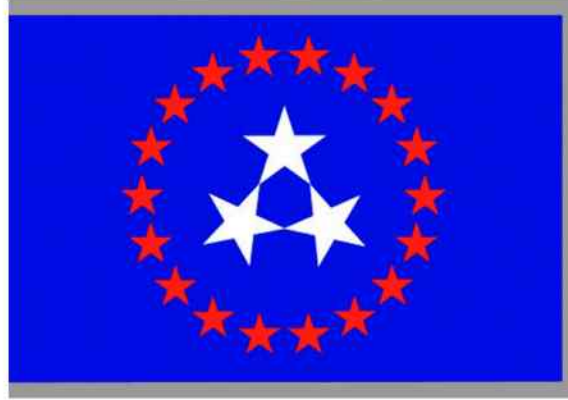

THE BEST OF LUCK TO D/CDR FRED SMITH, AP AND DISTRICT 3 FOR A SUCCESSFUL WATCH

D/Lt/C Tom Pilek, AP

D/Lt/C Luann Kazanecki, SN

D/Lt/C Betsy Mandara, AP

D/Lt/C Susan Beck, AP

D/Lt /C Sally Couluris, AP

D/F/Lt Diane Sherman, P

Chaplain P/C Mary Ann McCoy, SN

D/1st Lt Bob Bernstein, SN

D/1st Lt Lucy Jackson, SN

D/1st Lt George Hoffman, JN

Advisor Stf/C Angelo Giovannello, SN

Advisor Stf/C Robert Holub, SN

Advisor Stf/C Ann Peltier, SN

Advisor P/R/C Lawerence Postel, SN

Advisor P/D/C John Sanfilippo, AP

Advisor P/D/C Janet Taylor, SN

Aide D/Lt Sean Donohoe, SN

Aide D/Lt Lawrence Hynes, SN

Aide D/Lt Robert SanAngelo, SN

Aide D/Lt Christopher Smith, JN

THE BRIDGE *(cont'd.)*



ELIZABETH MANDARA, AP -Admin. Officer and Joseph

Betsy, husband Joe and son Joey joined Hempstead Bay in 2007 for the purpose of education and enriching their Sea Scout unit in Seamanship and boating safety. She served as Squadron Treasurer in 2009, AO 2010-, XO 2011, was a Lantern commander in 2012 and served on the squadron bridge as Secretary from 2012 to 2016. She has assisted District 3 as photographer from 2014-2015 as well as Assist. Treasurer in 2015 and Treasurer from 2016-2018.

Betsy is a retired Special Education teacher who taught severely emotionally disturbed children for over 20 years. She also has been involved with the Lions Club for over 12 years serving as president for 2 years and assisting with their Blind Bowling program and serving as a board member on their "Lend an Ear" program.

The entire family enjoys being on the water on their 34' Sea Ray, "Sea Dog".



SALLY COULURIS, AP -Treasurer

District Treasurer, Sally Couluris, joined the Neptune Sail & Power Squadron in 1999. She was elected Assistant Treasurer and worked her way up to Commander in 2006. In 2007 and 2008 she served as District Treasurer. Throughout the years, Sally has been Editor of the Neptune Log and has served as Neptune Treasurer for a total of six years. She has come back to District as Treasurer once again.

Sally, now retired, was a Contract Specialist for the Grumman Aerospace corp. She and her late husband, Paul, have three sons and five grandchildren, all of whom reside in Florida.



SUSAN BECK, AP - Secretary

Anative Long Islander who grew up in Westbury and learned how to swim at an early age due to her mother's fear of water. Since then, her own love of the water was born. In 2012, Sue took an ABC Boating Course and became a member of the United States Power Squadron. At the encouragement of Neptune members. Sue has taken all the major and elective courses available and is now taking the Junior Navigation course. She says that she is "hooked".

Sue joined the Neptune bridge in 2014 as Assistant Treasurer, two terms as Treasurer, and Executive Officer in 2017-2018.

The "Sail" class opened an entirely new world for her and has been lucky enough to take several sailing journeys; not limited to an ARC Rally adventure from Virginia to Bermuda in 2015.

On Tuesday evenings, during the summer months, you can find her "Sail" racing in Northport Bay.



DIANE SHERMAN, AP - Flag Lieutenant and Glen

Diane joined Peconic Bay Power Squadron in 2003, along with her husband Glen. Although she and Glen took the USPS Boating Course in 1995 with Great South Bay, they waited until they purchased their 44' Endeavor Power Cat before becoming USPS members. Diane has taken many seminars and courses over the years. She joined the Squadron Bridge in 2005 as Secretary, went up the Bridge and became Commander from 2012-2014, as one of Larry's Lanterns and Barry's Bosun's. She has been an aide to the D/3 Commander as well as District Chaplain twice. Diane has been working in the field of Special Education for 38 years as a counselor and a Music Therapist and has been educating special needs students for the past 30 years. She plans to retire in June 2018. Diane was also involved in Music Ministry at her church for 40 years., playing guitar, singing and directing the Contemporary Choir. She and Glen feel that education and safety are an important part of their boating lifestyle. they have lived aboard "DeptFree" full time for the last 15 years and hope to enjoy many more years and adventures aboard.

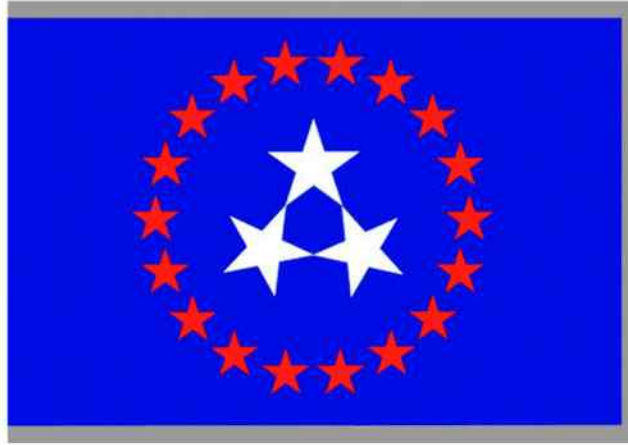

DISTRICT 3 FLAG

The District 3 Flag was approved by the National Flag and Etiquette Committee and adopted in 2000. The significance of the flag design is as follows: The three white stars signifying District 3 are enclosed in a circle of 18 red stars symbolizing the 18 squadrons of District 3 at that time.

The blue background symbolizes the waters surrounding Long Island. The flag is embellished with a platinum border signifying District 3 has attained its seventy-fifth anniversary.

This new District 3 flag was designed by Stf/C Angelo V. Giovanniello, SN.

D/3 DEFENDERS

District 3 is unique in the long standing tradition that the District Commander chooses an appropriate name and symbol to help maintain an identity for their year in office. This tradition started in 1965 with D/C Frank Haslach, N and his commanders, who realized that they would soon be going out of office "Has Beens." As commanders together they formed a close friendship and enjoyed each other's company at many events. They wanted to stay together as a group after their term of office had ended. The idea of having a unique name and later an identifying symbol caught on.

The D3 defenders theme was chosen envisioning Knights of Old, defending the kingdom against all evil. Further, the defenders served to protect the rights of the communities members, insuring that their voices were heard.

The logo became a shield with the D3 Flag as the "Coat of Arms". After further discussions with the Defender Team, the concept morphed to "Super Heroes", and super powers, which should add to this year's fun. As part of the fun, The Commanders and Squadrons have agreed to a friendly competition, who can display the logo most creatively?

D3 Defenders are a team working together, striving to attain the greatest "Super Power", the Power to Inspire.

Haslach's Has Beens
Pallas Guards
Angnello's Angels
Earl's Pearls
Tom's Cats
Raskin's Rascals
Donald's Ducks
Wally's Wheels
Kess' Crew
Burgio's Buoys
The Marksmen
Bob's Beacons
Shed's Sharpies

Howard's Skippers
Bill's Bosun's
Braun's Buccaneers
Danny's Dolphins
The Whales
Davis' Clippers
Holub's Seahorses
Pollio's Pilots
Al's Anchors
Leo's Lights
Guy's Gulls
Joe's Mariners
Dave's Dories

Karl's Cruisers
Harry's Helmsmen
Jack's Stars
Montague's Marlins
Friedland's Fisherman
Ron's Rays
Terry's Pirates
Bradley's Barracudas
Camelot Commanders
The Leprechauns
Frenz's Frigates
Bob's BraveHearts
Angelo's Angels

Taylor's Tankers
Friedmann's Foghorns
Bob's Buccaneers
Pete's Pelicans
Gar's Lifesavers
Sanfilippo's Penguins
Eric's Eagles
Larry's Lanterns
Barry's Bosuns
Dan's Navigators
Peltier's Pearls
Neil's Dolphins
The Seafaring Frenz

THE BRIDGE *(cont'd.)*

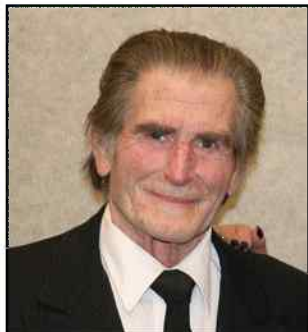

Robert Bernstein, SN
Asst Educational Officer



Lucy Jackson, SN
Assistant Secretary



George Hoffman, JN
Assistant Treasurer



Mary Anne McCoy, SN
Chaplain

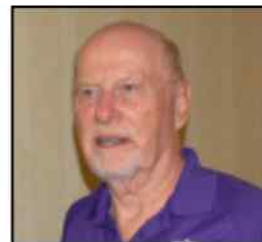

AIDES: P/C Sean Donohoe, SN; P/C Christopher Smith, JN; P/C Steve Burke, P;
P/C Lawrence Hynes, SN; P/C Robert SanAngelo, SN

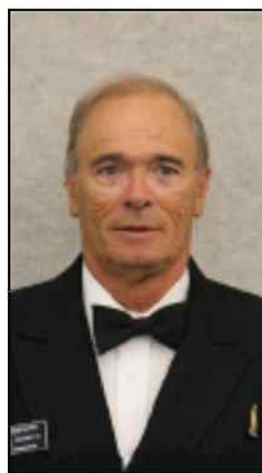

ADVISORS: Stf/C Angelo V. Giovanniello, SN, Stf/C Ann Peltier, SN, P/R/C Lawrence Postel, SN,
P/D/C Janet Taylor, SN, Stf/C Robert Holub, SN, P/Stf/C John Sanfilippo, AP



**THE COMMANDERS OF
DISTRICT 3
WISH FRED SMITH, AP
THE BEST OF LUCK AND
A SUCCESSFUL WATCH**

Bayside	Gil Allen, SN
Captree	Lea Tracy, P
Great South Bay	John Pergola, AP
Hempstead Bay	Steven Strauch, P
Jones Beach	Darrin Lehr, S
Moriches Bay	Peter Ljungqvist, JN
Neptune	Mel Adler, AP
Oyster Bay	Ann Peltier, SN
Patchogue Bay	Michael Sawaya, S
Peconic Bay	George Kay, P
Port Washington	Joseph Lauricella, SN
Sewanhaka	Fred Deppert, AP
Smithtown Bay	Thomas Rondi, AP
South Shore	Wilton W. Widman, SN

SQUADRON



COMMANDERS



BAYSIDE

GILC. ALLEN, SN

142-01 37th Avenue, Flushing, NY11354 • 516-551-9883
nella7788@verizon.net

Meetings: 3rd Monday of the month, St Anastasia's Annex, Douglaston



GREAT SOUTH BAY

JOHN PERGOLA, AP

71 Highland Avenue, Patchogue, NY11772 • 631-758-4086
rckids@aol.com

Meetings: 4th Friday of the month, Rusy Bohm American Legion Hall, Islip



BROOKLYN

MICHAEL McCAFFERTY, Pand Mary

183 79th St, Brooklyn, NY11209 • 718-680-2050 • (B) 718-248-4871
mmccafferty4871@aol.com

Meetings: TBA



HEMPSTEAD BAY

STEVEN STRAUCH, Pand Maria

723 West Broadway, Woodmere, NY11598 • 516-209-1899
stevenstrauch1@gmail.com

Meetings: 1st Thursday of the month, East Rockaway Yacht Club



CAPTREE

LEATRACY, P and George

19 Lewis Circle, Babylon, NY11702 • 631-539-4006
ltracy@optonline.net

Meetings: 3rd Wednesday of the month, Moose Lodge, Lindenhurst



JONES BEACH

DARRIN LEHR, S and Lucy

8 Elsie Lane, West Farmingdale, NY11735 • 516-497-1545
darrinlehr@optimum.net

Meetings: 1st Thursday of the month, American Legion Hall, Seaford



ACTIVITIES OF DISTRICT 3

Long Island Duck's Game - 3 June 2018

District 3 will again be attending the Long Island Duck's Game at Duck's Stadium in Central Islip. Prior to the game there will be an all-you-can-eat BBQ. Come and participate in the pre-game on-field ceremonies where we will have our picture taken with life jackets.

Rendezvous East - 27-28 July 2018

Mitchell Park Marina, Greenport, NY

District 3 will be returning to Mitchell Park Marina in Greenport. Come early and join us for the D/C's Cocktail Party Friday afternoon and Friday night's Karaoke/Music.

Saturday morning will begin with a flag raising ceremony; a Bocce Tournament hosted by Peconic Bay; the afternoon is where you want to be for squadron hospitality and in the evening a "Defender's Theme" dance - dress is red, white & blue.

Chairmen:

D/Lts John & Loretta Yeamans, SN - 631-736-0541

Fall Educational Conference-Melville Marriott - 2 November, 2018

The morning of the Educational Conference is devoted to seminars on USPS education courses. There is also a juried display of teaching aids submitted by the various squadrons. After lunch the D/3 Conference convenes to act on district business and present education and teaching aids awards.

Chairman: P/C Charles Virga, JN - 631-661-6373

Spring Conference and Change of Watch - 29-30 March 2019

The Spring Conference weekend will be held at the Melville Marriott. It begins with the D/C s' cocktail party Friday evening. On Saturday morning there is a keynote speaker followed by workshops for the various committees. After lunch, the conference reconvenes with District awards and concludes with the District Change of Watch. Squadrons open their hospitality rooms in the afternoon and a dinner dance closes the festivities Saturday evening.

Chairmen:

Stf/C Angelo V. Giovanniello, SN - 631-661-5318

Fall Educational Cruise - 30 September 2018 on the Dixie II out of Captree State Park

Boarding is at 1715 with departure being 1730 and will

be returning approximately 2000 allowing time to see aids to navigation in the daylight and those that are lit at night. Bring food and a non-alcoholic beverage along and make it a family outing.

Chairman: D/Lt Gene Johnson - 631-242-6117

Educational Hotline - 1-800-341-USPS (8777)

The educational hotline gives callers information on boating courses in their area. The recorded message gives the dates, locations and contact persons for the boating courses offered by squadrons of D/3. Messages are updated continuously.

Chairman: Linda Bradley, SN - 631-243-5240

Boat Shows

District 3 secures space and sets up a booth at local boat shows to dispense information about boating classes and USPS. We are represented at boat shows held at TOBAY, Javits Center, Nassau Coliseum and other local venues. The booth is staffed by representatives of the D/3 squadrons.

Co-Chairmen: D/Lt Fred Deppert, AP - 516-379-8320 and D/Lt Steve Burke, P 516-965-4716

Council Meetings

D/3 Council meetings are scheduled on **9 March, 1 June, 19 October 2018 and 8 March 2019 at the Melville Marriott**. One may come for attitude adjustment hour at 1830 and dinner at 1900, The meetings begin promptly at 2000. All members of District 3 are welcome.

Memorial Service - Sunday 8 April 2018

On Sunday afternoon members, families and friends pause to remember those members of our district who have departed from us during the year. Refreshments follow the church service.

Chairman: J/P/D/C Ann Frenz, SN, 631-472-1926

Website

The District maintains a website, weboatsafe.org and usps.org/localusps/D3 to keep members up-to-date on all the happenings in District. Looking for a specific course? The website lists member courses offered by the squadrons as well as public boating courses. You will also find the district calendar which lists the various social activities happening in squadrons around Long Island. All activities in any squadrons are open to any USPS member.

Webmaster: P/D/C Ann Peltier, SN, 631-447-1051



MORICHES BAY

PETER LJUNGQVIST, JN and Kathy

306A South Country Road, Brookhaven, NY11719 • 631-286-4840

peter.ljungqvist@thorn.net

Meetings: 4th Tuesday of the month, JC's Restaurant at Mike's Place Too, Mastic



OYSTER BAY

ANN PELTIER, SN and Thomas

92 Log Road, Patchogue, NY11772 • 631-447-1051

apeltier@optonline.net

Meetings: 2nd Monday of the month, Sagamore Yacht Club, Oyster Bay



NEPTUNE

MEL ADLER, AP and Louise

37 Croft Lane, Smithtown, NY11787 • 917-560-5788

meladin2@gmail.com

Meetings: 3rd Thursday of the month, Northport Yacht Club



PATCHOGUE BAY

MICHAELSAWAYA, Pand Karen

7 Tranquil Court, Bayport, NY11705 • 516-659-7758

mssawaya@aol.com

Meetings: 2nd Friday of the month, Suffolk Boat Club, Patchogue



OLD FIELD POINT

RONALD GUZEWICH, SN and Terry

10 Andrea Drive, Setauket NY11733 • 631-689-3982

rguzewich@msn.com

Meetings: 1st Monday of the month, Mount Sinai Yacht Club



PECONIC BAY

GEORGE KAY, AP and Mary

801 Aerie Way, East Quogue, NY11942 • 631-509-7860

geokae1@gmail.com

Meetings: 3rd Thursday of the month at various locations



What is a Vessel Safety Check?

A vessel safety check is a courtesy examination of a boat to verify the presence and operable condition of certain safety equipment required by state and federal regulations. The Vessel Examiner is a trained specialist and is a member of the US Power Squadrons or the US Coast Guard auxiliary. They will also make certain recommendations and discuss safety related issues that will make boat owners safer boaters.

The inspection is really quick and easy. Many trailerable boats can be inspected in ten minutes. All boaters will receive a copy of the evaluation format at the end of the inspection. Boats that meet the safety requirements will receive a current Vessel Safety Check decal to be displayed on board.

Trailer Boats can be brought to selected marine centers or arrange for a future VSC appointment at their boat launches, marinas or yacht clubs with a Vessel Examiner in your area from the list shown on the left. Vessel Safety Checks are not a boarding or a law enforcement issue. No citations will be given if boats do not meet safety requirements. Your boat will pass inspection once the requirements are met. Listed on left are the Vessel Safety Check Chairmen.

District 3 Squadrons and Vessel Safety Check Contacts

SQUADRON	CONTACT	
1 BAYSIDE	EUGENE MOLteni, SN	718-224-2124
2 BROOKLYN		
3 CAPTREE	CHARLES VIRGA, AP	631-661-6373
4 GREATSOUTH BAY	FRANK DeMAYO, JN	631-993-5228
5 HEMPSTEAD BAY	NEILF. PHILLIPS, JN	516-652-3554
6 JONES BEACH	BUTCH BONCZYK, SN	516-456-1152
7 MORICHES BAY	RICHARD LANNI, P	631-399-2766
8 NEPTUNE	DON LaGRECO, AP	631-478-8817
9 OLD FIELD POINT	JOHN PETERSON, S	631-585-7432
10 OYSTER BAY	KEVIN KUO, P,	516-433-2073
11 PATCHOGUE BAY	ROBERTGROOS, SN	631-879-8686
12 PECONIC BAY	MICHAELREMSKI, JN	631-790-7335
13 PORTWASHINGTON		
14 SEWANHAKA	ROBERTSTEEL, AP	516-872-8167
15 SMITHTOWN BAY	ALLAN HILTUNEN, SN	631-265-6561
16 SOUTH SHORE	SETH GOLDSTEIN, JN	516-779-9958

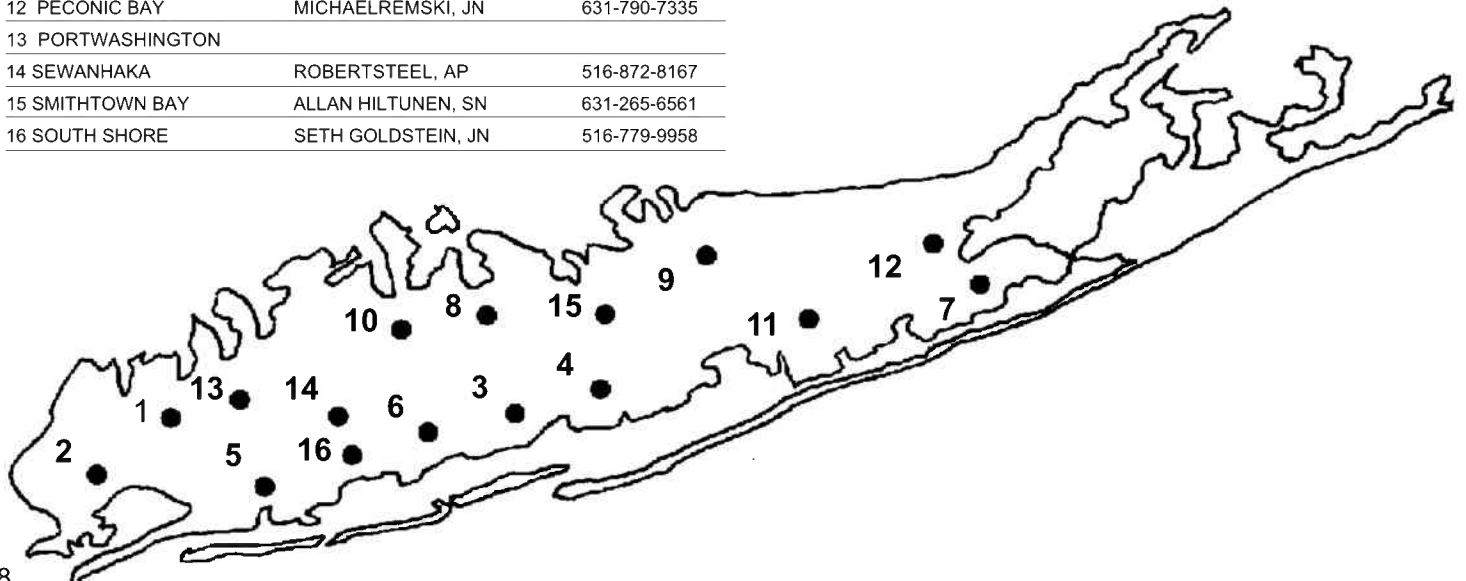



PORT WASHINGTON

JOSEPH LAURICELLA, SN and Mary Anne
9 Wyndham Way, Port Washington, NY11050 • 516-944-9863
k2olc@verizon.net

Meetings: 3rd Monday of the mo., N. Shore Yacht Club, Port Washington



SMITHTOWN BAY

THOMAS RONDI, AP and Ann Marie
103 Harvard Avenue. Smithtown, NY11787 • 631-338-0656 (c)
tom@tomrondi.com

Meetings: 2nd Wednesday of the month, Stony Brook Yacht Club



SEWANHAKA

FRED DEPERT, AP and Christina
52 East Bedell Street, Freeport, NY11520 • 516-379-8320
fdeppert@optonline.net

Meetings: 3rd Thursday of the month, Guy Lombardo Marina. Freeport,



SOUTH SHORE

WILTON W. WIDMAN, SN and Margaret
138 Sheffield Avenue, North Babylon, NY11703 • 631-669-3821
peg55wil@aol.com
Meetings: 3rd Thursday of the month, American Legion Hall, Seaford



Maiden USA

FRED, NANCY & OZZY



"Grateful"

CONGRATULATIONS
TOM & ALICIA PILEK



Instigator

GENE & LUANN



Sea Dog

BETSY, JOE & JOEY
MANDARA



DISTRICT SECRETARY
SUSAN BECK, AP



DISTRICT TREASURER
SALLY COULURIS, AP



DISTRICT 3 GENEALOGY

By 1938 the United States Power Squadrons was an organization of 5,000 members with 33 squadrons. That year the Governing Board approved the establishment of 7 divisions and they appointed a Rear Commander to administer each division. Later the designation division was changed to District and in 1947 the officer in charge was changed to the elected position of District Commander. The New York squadron had provided pre-charter instruction to the Brooklyn (1918) and South Shore (1928) squadrons. Brooklyn helped to establish Bay-

side (1936) which, in turn, spun-off Neptune (1938). District 3 was officially established on 13 December 1938 to include the Brooklyn, South Shore, Bayside, and Neptune squadrons. The district grew for thirty-five years reaching a peak in 1970 of over 5,000 members in 21 squadrons. With less interest in boating, membership declined drastically during the late 70s and early 80s, but the tide has turned and District 3 has again begun to grow. In 2017 District 3 now has 16 active squadrons.

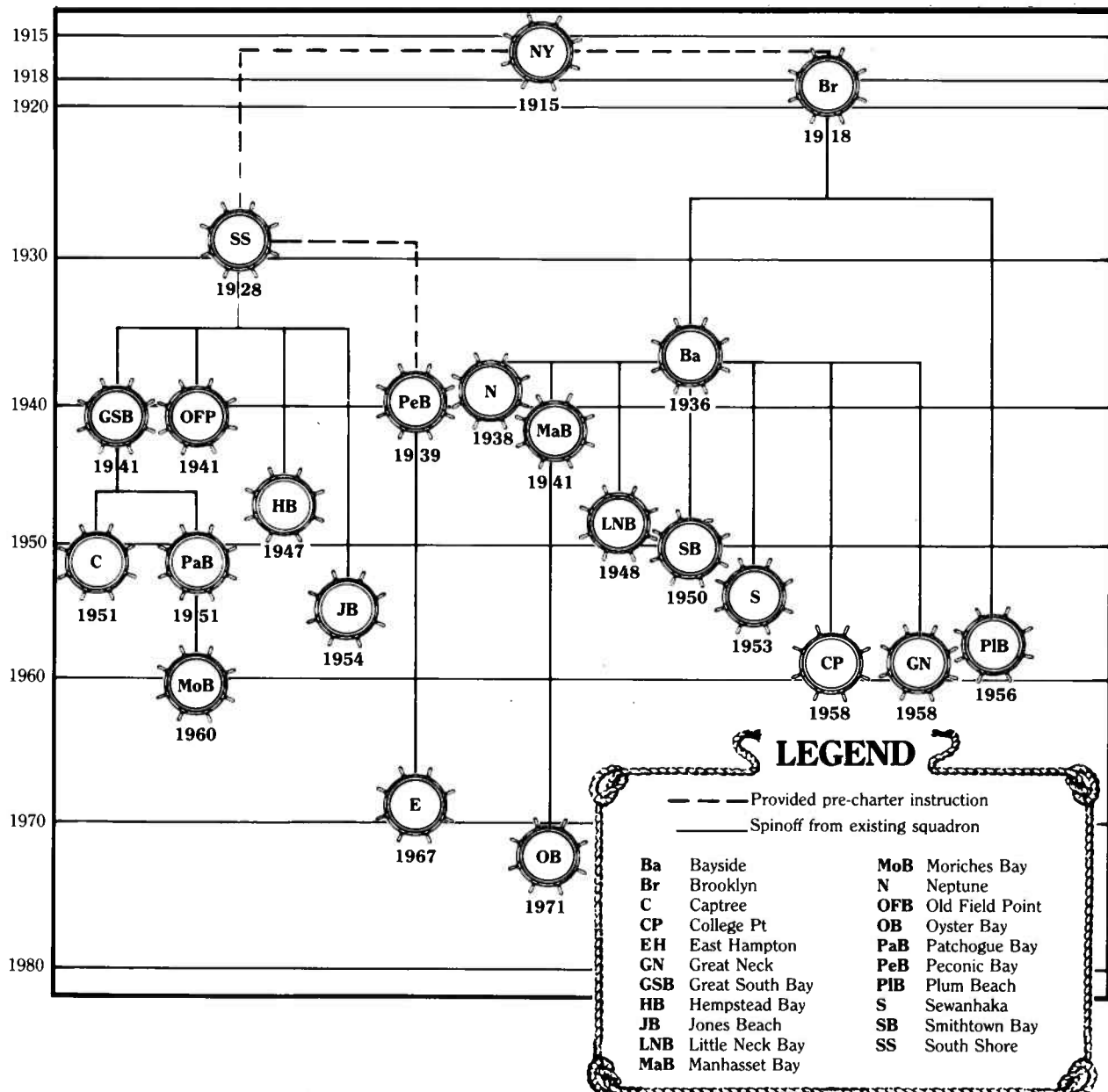



DISTRICT 3 AWARDS AND TROPHIES

Cruise and Rendezvous Trophy

The present Cruise and Rendezvous Trophy, a large handsome trophy cup mounted on a two-tiered walnut pedestal, is a perpetual District 3 award presented annually at the Fall Conference for boating participation at the District Rendezvous. The winner of the trophy is determined by a formula that takes into account the distance traveled to the Rendezvous location, and the number of squadron boats in attendance relative to the total membership of a squadron.

The idea of a Cruise and Rendezvous Trophy was jointly conceived by the members of Patchogue Bay and Peconic Bay squadrons. The original trophy, donated by Peconic Bay Power Squadron in 1967, was to be an annual award with the stipulation that any squadron that won the award three times would be entitled to keep it. Patchogue Bay succeeded in winning the award in 1968, 1969, and 1970. Thus they took permanent possession of the original trophy. To continue the award the following year Patchogue Bay donated a new trophy for presentation with the same contest rules applying. It did not seem

likely that a squadron could dominate the competition again. However, Great South Bay Power Squadron achieved this winning the trophy in 1971, 1972, and 1973.

The following year, Great South Bay Power Squadron reinstated the award. This time, however, the "three consecutive wins" rule, entitling a squadron to keep the trophy, was dropped to assure that this would be a perpetual award. Great South Bay squadron purchased the present trophy and deeded it to the District in 1974. Great South Bay has gone on to win the award 29 of the 35 years, including seventeen years in a row. In 2014 Jones Beach won the award and in 2013, 2015 & 2016 the trophy was won by Patchogue Bay.



PRINCE HENRY AWARD

The seated likeness of Prince Henry the Navigator of Portugal was given to a number of USPS districts by the government of Portugal for promoting education in the art of navigation.

In D/3 this award is presented at the Spring Conference to the squadron who had the highest percentage of members advance in grade. The recipient is determined by a point system that takes advanced grades relative to the total membership of the squadron.



HAEDRICH MEMORIAL TROPHY

The Brooklyn Power Squadron established the Haedrich Memorial Bell Trophy in remembrance of Harold W. Haedrich who was a past commander of Brooklyn Squadron and one of the original commanders of District 3. The ringing of the Haedrich bell traditionally opens and closes our district conferences.



The trophy is awarded at the Spring Conference based on a complex formula that takes into account advanced grades and elective courses completed and membership retention.



DISTRICT 3 AWARDS AND TROPHIES



KARL WALTER MEMORIAL AWARD

Sewanhaka squadron established this contemporary looking trophy in 1983 to perpetuate the memory of P/C and DEO Karl Walter, N.

At the Fall Conference the recipient of the Karl Walter Memorial Trophy is the squadron that has the best progress in advanced grades, boating course enrollment and new members continuing their education.



GEORGE W. POPELLA MEMORIAL AWARD

Sewanhaka Power Squadron established the Popella trophy in 1987 in memory of one of their members, George W. Popella, N. Popella had been very active in the Cooperative Charting program and had received many awards for his work and charting submissions.

The trophy is awarded at the Spring Conference to the squadron that had the highest percentage of members participating in the current year's Cooperative Charting Program.



JERRED MEMORIAL TROPHY

The 1967 Commanders of District 3 deeded this silver bowl trophy to the district to honor the memory of Leon S. Jerred, AP, who was the 1967 Commander of Peconic Bay. At the time of his death Jerred was the District Teaching Aids Chairman.

The Jerred Trophy is awarded at the Fall Conference to the squadron who has entered the teaching aid judged "Best in Show" at the Conference.

ANTHONY A. SCIMECA MEMORIAL AWARD

The Scimeca plaque was instituted by South Shore Power Squadron to honor P/D/C and P/R/C Anthony A. "Doc" Scimeca and outstanding boating educators in District 3.

The plaque is presented at the Fall Conference to the person who has been selected as the District 3 nominee for the Chapman Award.





DISTRICT 3 AWARDS AND TROPHIES



THE COMMANDER'S CHALLENGE

The Commander's Challenge trophy was unveiled at the 2004 Spring Conference. This award challenges squadron officers and members to become involved in the many aspects of USPS. It is a challenge to the squadron leadership to increase participation in the total USPS experience on the squadron, district and national level and to increase participation in a variety of USPS activities.

Points will be awarded for participation in various educational, civic service and fraternal boating activities. Since squadrons differ in size, participation will be determined on a percentage basis giving all squadrons an equal chance of winning. Filing required reports on time and attendance at required meetings will also be rewarded with points. This is a challenge to squadron officers to do their jobs and to increase the involvement of squadron members.

The winner of the Commander's Challenge is the squadron that accumulates the greatest number of points in the qualifying period of 1 March to 28 February. The Commander of the winning squadron will be presented The Commander's Challenge Trophy at the Spring Conference. Squadrons that place second through fifth will also be recognized.



THE DOMINICK SEGRETE MEMORIAL AWARD

Sewanhaka Power Squadron created the Dominick Segrete Memorial Award in 2005 to honor their past Commander and his work teaching and recruiting new members from boating classes and immediately involving them in squadron activities. He was also a strong advocate of squadrons sharing resources to offer more boating classes in convenient locations and at the times students wanted the course. Dominick was also instrumental in launching the D/3 Journal.

Awarded at the Fall Conference the Segrete Award honors a member of D/3 who has gone above and beyond for his own or another squadron in District 3. This might be accomplished by teaching, recruiting members, mentoring and/or promoting the goals and objectives of USPS.

SHIPPING OVER AWARD

The Shipping Over Award was conceived in 1988 by P/C Morris Ripps, N (Bayside) and P/C Joseph Zimmer, AP (Smithtown Bay) who were chairmen of the D/3 Membership and Membership Retention committees. The plaque is presented at the Spring Conference to the squadron having the highest percentage of regular member renewals at the beginning of the membership year.



DISTRICT 3 AWARDS AND TROPHIES

ROBERT R. RACHOI MEMORIAL AWARD

To memorialize P/D/C and P/R/C Robert Rachoi, N, Hempstead Bay Power Squadron established this award in 1990. The award pertains to Operations Training because Rachoi was chairman of the National USPS Operations Training Committee.

The squadron having the greatest participation in the Operations Training program the previous year receives the Rachoi Award at the Spring Conference.



ALVIN J. WELLANDER, AP MEMORIAL AWARD

DISTINGUISHED EDUCATIONAL OFFICE AWARD a/k/a DEO AWARD

The DEO Award was instituted by the Great Neck Power Squadron not to honor a person, but to honor the office of District Education.

The award is presented at the Spring Conference for squadron participation in the previous Fall Conference. The recipient is determined by the number of members in attendance, participation in the workshops and the number of teaching aids exhibited relative to the size of the squadron membership.

This award was established by Hempstead Bay Power Squadron in 2017 to memorialize P/D/C Al Wellander, AP. The award is in recognition of a Squadron's excellence in educating the boating public--Al's greatest love in USPS. The squadron having the highest number of graduates of the public boating course during the previous calendar year will receive the Alvin J. Wellander, AP Memorial Award at the Spring Conference.



*If you think you can't buy American ...
Think Again!*



*Stop by and
see the best
of our country's
creative talent!*



WWW.ECOLIN.COM

PORT JEFFERSON
Lighthouse Landing
14 East Broadway
631.473.1117



981816

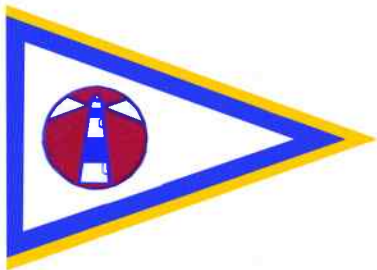

**Congratulations to
District Commander
Fred Smith, AP
from the membership of
GREAT SOUTH BAY
POWER SQUADRON
Have a Great Year!**

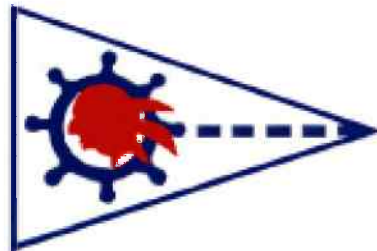

**PATCHOGUE BAY
POWER SQUADRON
CONGRATULATES
COMMANDER
FRED SMITH, AP
AND THE
DISTRICT 3 BRIDGE**





AMERICA'S BOATING CLUB

**BAYSIDE
CONGRATULATES**

**DISTRICT
COMMANDER
FRED SMITH, AP
and
THE DISTRICT 3 BRIDGE
our
"D/3 Defenders"**



8 Morton Street
Farmingdale, N.Y. 11735
516-698-5637
pcgeorge70@yahoo.com

"Only Quality Parts and Service"

Dragon Computers

Quality Custom Made Computers



For
Home or Work
Internet • Gaming

Let the
Computer Nerd
make the computer
YOU want!

**District Commander
FRED SMITH, AP**

**Wishing you
Calm Seas
and
Smooth Sailing**

**D/Lt/C Betsy Mandara, JN
P/C Joe Mandara, JN**

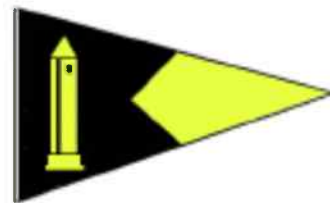

**JONES BEACH
POWER SQUADRON
CONGRATULATES
DISTRICT
COMMANDER
FRED SMITH, AP
And The
DISTRICT 3 BRIDGE**

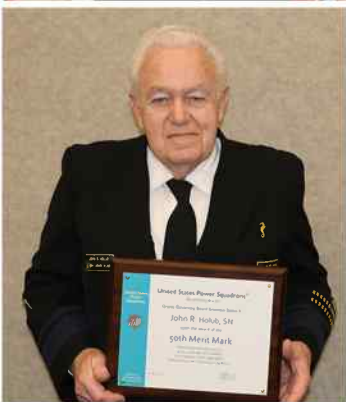



**Oyster Bay Sail and
Power Squadron**

**Thank you to
P/D/C Ann Frenz and her
Seafaring Commanders
and
Wishing a Super Hero Year
to
District Cdr Fred Smith
and his
D3 Defenders!**



CAPTREE

**POWER
SQUADRON**

**CONGRATULATES
DISTRICT 3
COMMANDER
FRED SMITH, AP
AND HIS DEFENDER
BRIDGE**

LET THE FUN BEGIN!

**Best Wishes to
Commander
FRED SMITH, AP
and the
Defender
Commanders**

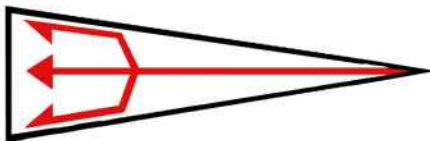

**From the members of
Neptune Sail and Power
Squadron**



**SOUTH SHORE
POWER SQUADRON
CONGRATULATES
DISTRICT
COMMANDER
FRED SMITH, AP
And The
DISTRICT 3 BRIDGE**





COLD SPRING MOTORS

(631) 692-9585

For All Your Automotive Needs

All Makes and Models

JOE

**Email: csmotors@optonline.net
www.coldspringmotors.com**

**27 Harbor Road
Cold Spring Harbor, NY 11724**

**Best Wishes to
District 3
Commander
Fred Smith, AP
and the
Defenders**

**From the members of
Port Washington
Sail and
Power
Squadron**

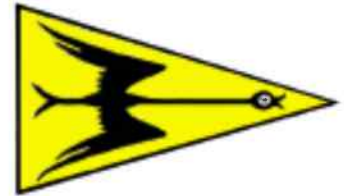

Janice Redmond, CPA
janice@janicedmondassociates.com

**JANICE
REDMOND & ASSOCIATES**

CERTIFIED PUBLIC ACCOUNTANTS

**140 Fell Court - Suite 116
Hauppauge, New York 11788**

**P 631-342-9589 • F 631-342-0338
www.janicedmondassociates.com**

**YOUR DEDICATION
TO PECONIC BAY,
DISTRICT 3
AND USPS IS
SINCERELY
APPRECIATED**

**ROBERT & ROSANNA
WALTHER**





TOWNSEND MANOR INN

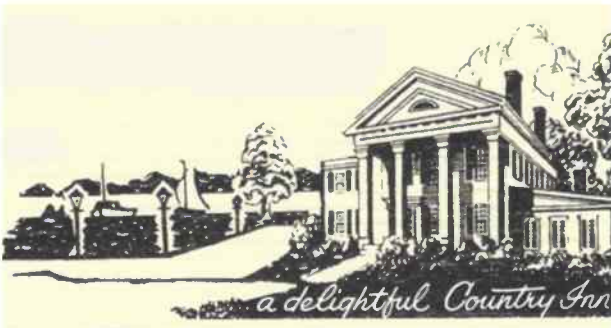

RESTAURANT • HOTEL MARINA

SCOTT GONZALEZ
714 Main St. Greenport, NY 11944
Tel 631-477-2000 • Fax 631-477-2371
www.townsendinn.com

Stuarts Pharmacy

"Long Island's premier independent pharmacy"



OVER 40 YEARS FAMILY
OWNED AND OPERATED...
WE THANK YOU!



FRANCO DORIA RPH

OWNER

681 Broadway, Massapequa, NY 11758

phone 516-799-5858 ext 14
Fax 516- 799-5882

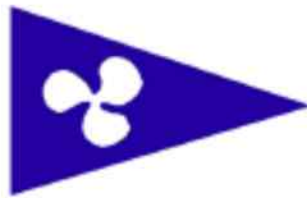

**MORICHES BAY
POWER SQUADRON
CONGRATULATES
DISTRICT
COMMANDER
FRED SMITH, AP
and The
DISTRICT 3 BRIDGE**

**Best Wishers to
District 3
Commander
FRED SMITH, AP
and The
DEFENDER
Commanders**

**From the
members of
Hempstead
Bay Power**

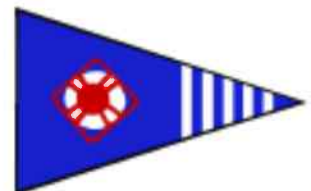





 **Congratulations to Fred and all his D3 Defenders**

from **HappyCove.com**
 where everything is just a little bit better.
 Innovative, high quality,
 hard to find, products
 for boats and boaters.



(516) 944-6497 DOM D'ALONZO

DOM'S

TREE SERVICE

101 Harbor Road • Fort Washington, New York 11050

DORAMAR
 CANVAS PRODUCTS

FABRIC COVERS FOR ALL APPLICATIONS

182A Cherry Ave
 West Sayville, NY 11796
 Email: info@doramar.com

Tel: (631) 750-9202
 Fax: (631) 750-9203
 www.doramar.com

ALL AMERICA
TRANSPORT

Joseph Mandara

Relationship Driven, Performance Proven

739 Dogwood Avenue
 West Hempstead, NY 11552
 allamericatransport.com

(516) 565-2370
 (212) 307-1234
 Fax: (516) 565-2374

Thomas F.
DALTON
 FUNERAL HOMES, INC.

2786 Hempstead Turnpike
 Levittown, N.Y. 11756
 Phone (516) 796-0400
 Fax (516) 796-3890

47 Jerusalem Avenue
 Hicksville, N.Y. 11801
 Phone (516) 931-0262
 Fax (516) 933-6907

Beth Dalton-Costello

Chapels also available in:
 Floral Park
 New Hyde Park
 Williston Park

www.daltonfuneralhomes.com

O: 631.924.2200
 M: 516.805.6100
 F: 631.924.6057
 E-Mail:
 john@jcs closets.com

JOHN PERGOLA

55 Brook Avenue,
 Deer Park, 11729

WWW.JCSCLOSETS.COM



 **Bottles on Broadway, LLC**
 Fine Wines and Spirits
 Ms. Rinda Palya
 Proprietor

1083 North Broadway
 Massapequa, NY 11758

Phone: 516-694-1909
 Fax: 516-694-1927
 bottlesonbway@optonline.net

Mon- Wed 9:30-8, Thur 9:30-9, Fri-Sat 9-9, Sun 12-6





Muana

Stf/C NINA & Stf/C GUY
ANASTASIO

Camelot

PEARL & ED BAUER

Blue Eyes

Stf/C ROBERTHOLUB, SN
& NANCY

Avanti

Stf/C ANGELO GIOVANNIELLO, SN
& JONI

Best Wishes

GAR & BARB COMB

Pennies from Heaven

P/R/C LARRY POSTEL, SN

ANN & TOM ARE
In The Mood

Carole Lee

NEIL & CAROLE PHILLIPS

Best of Luck To The Bridge

D/1st Lt GEORGE HOFFMAN

Debtfree

GLEN & DIANE
SHERMAN

Freedom

GIL ALLEN

Eleanor Lee

LEA & GEORGE TRACY

Summer Slopes Too

GEORGE & MARY KAY

Mary Anne & Joe

Southern Cross

CDR FRED DEPERT

Honey Bunny

WILL & PEGGY WIDMAN

Our Dream

HEIDI & BOB DEARING

Daddy's Dream

LUCY & BOB JACKSON

Summer Breeze

GENE & SHARON MOLTENI

Cativelle

BETSY, JOE & JOEY
MANDARA

Still Looking

P/C SEAN P. DONOHOE

Kristin Ann

CAROL & GENE JOHNSON

Follow Me III

P/C RICHARD JOST & DIANE

Irish Roots

TOM & MARY MARKUNAS





Congratulations
SMITHTOWN BAY

Congratulations
CAPTREE

BEST WISHES FOR 2018
OLD FIELD POINT

Nanseä
P/C LAWRENCE HYNES

"Tachyon"
NANCY & BOB GROOS

Auntie Mame II
MARYANN & JOSEPH
MARTORANO

Capriccio
NICK & JOAN WORONTZOFF

Tin Man
JOEL & HELEN NOLIN

Angela Mia
DOM & MARIA D'ALONZO

Uncorked
KATHY & FRANK

CONGRATULATIONS
Carpet Bagger
MUCH SUCCESS

VINCE & LIZ
MAUCERI

KATHLEEN WELLS
PATCHOGUE BAY
POWER SQUADRON

Ynaut
JOHN & LORETTA
YEAMANS





J. Foster Phillips Funeral Home, Inc.

Congratulations to District 3 Commander Fred Smith, AP and his Bridge

P/D/C NEIL FOSTER PHILLIPS, Licensed Funeral Director,
President/CEO
CAROLE TEMPLE PHILLIPS, Licensed Funeral Director,
Vice President



**Family Owned & Operated Since 1929
718.526.5656**

**179-24 Linden Boulevard • Jamaica, New York 11434
Fax: 718.658.7859**

**www.jfosterphillips.com
Consultation for Worldwide * At need & Pre need arrangements
*Hablamos Espanol * Nous Parlons Francais***

The above named funeral firm is owned in whole by Neil Foster Phillips. Licensed Funeral Director

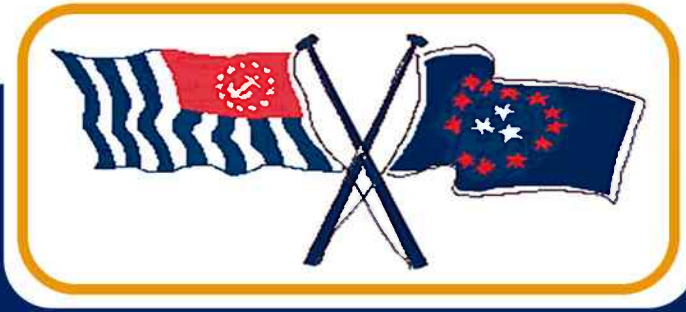

DISTRICT 3 2018 JOURNAL



**UNITED STATES
POWER SQUADRONS**